

Article number: 203160M1041B3X

Description: E+G levelling foot

GN 31-60-M10-41-B3-X

Note: X With female thread, External hexagon

Measures

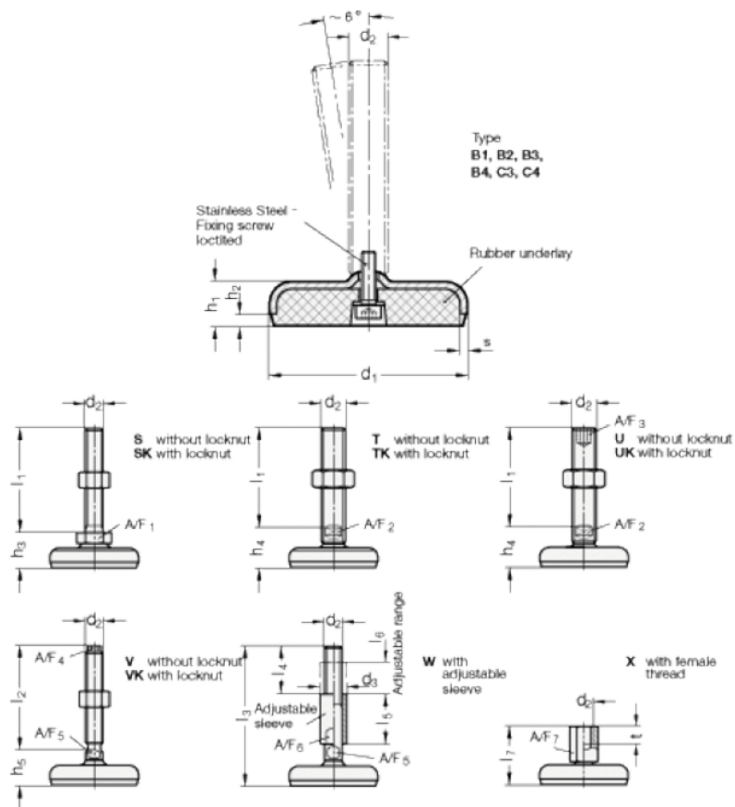

A/F7	= 14
d1	= 60
d2	= 10
h1	= 16
h2	= 4
l7 +4.0/0	= 41
s	= 3
t	= 10